

EXEN
by
bürotime

technical document



EXEN



“Pedagogical approaches that change along with technology accelerates the alteration towards student-oriented, active learning environments while creating opportunities for new learning methods. As Burotime, inspired by active learning approaches that do not limit education to defined spaces, we offer effective solutions that will convert every corner of the educational institution into a learning space.”



Karakteristik çizgisiyle ile ön plana çıkan Exen; aktif öğrenme yaklaşımlarına göre şekillenen yeni nesil sınıflar için başarıyı üst noktaya taşır. Dayanıklılık ve işlevselliği birleştiren zarif ayak tasarımı, farklı yaş gruplarına uygun yükseklik seçenekleri ile uzun ömürlü kullanıma olanak verir.

Sıra altında bulunan kitap rafı ve çanta askılığı çalışma ortamında düzen oluşturarak öğrenim ortamına bağlılığı destekler.



product family _____



single desk

double desk

table sizes _____

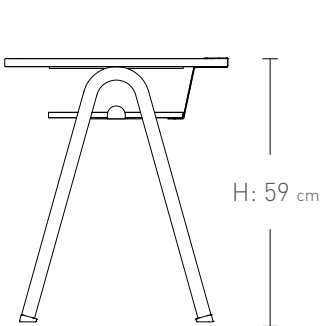
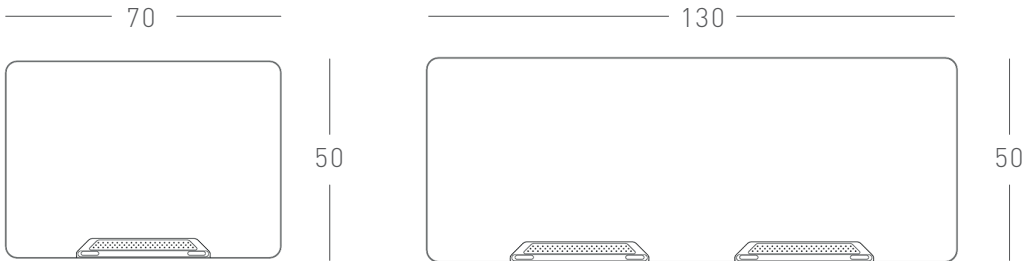

small
6-8 years

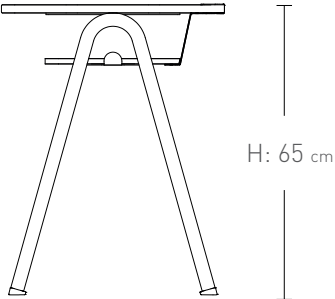

medium
8-11 years

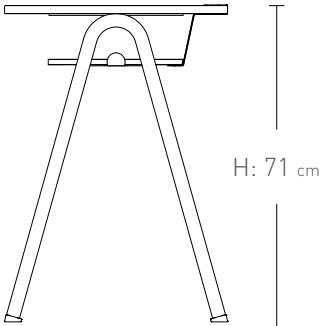

large
11-14 years



color options melamine

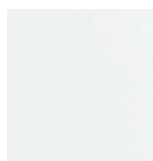

white

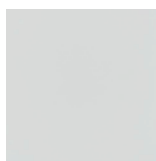

grey

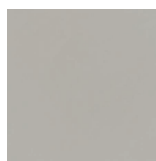

sand

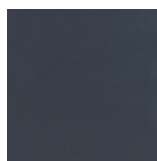

antrachite

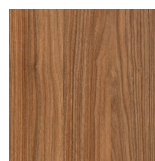

samba walnut

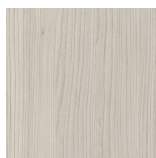

oleaster

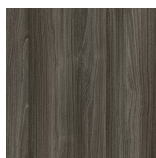

ash oak

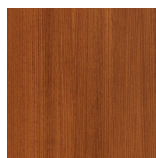

hazelnut



acacia



natural oak

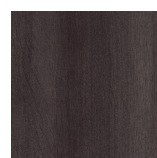

african oak

metal

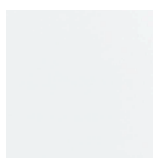

white

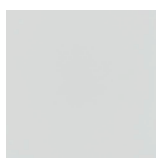

grey

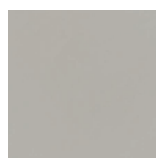

sand

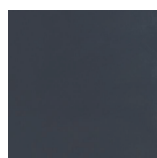

antrachite



black